



**CLAVIJAS Y TOMAS  
INDUSTRIALES  
INDUSTRIAL  
PLUGS AND SOCKETS**

**CAMPING & MARINA**

**Famatel®**

**Nuevo sistema con microinterruptor**  
New microswitch system



**Ingenuity and  
electrical solutions**

## Empresa

Somos **fabricantes especializados en el sector eléctrico internacional** con más de 30 años de trayectoria desarrollando soluciones eléctricas que aportan valor a los profesionales.

## Company

We are **specialised manufacturers in the international electrical sector** with more than 30 years of experience developing electrical solutions that provide value to professionals.

**Las cifras que nos avalan**  
The figures speak for themselves

**+ 30**   
**Años de experiencia**  
Years of experience

**+ 450**   
**Profesionales**  
Professionals

**4**   
**Centros de producción**  
Production hubs

**+ 3.000**   
**Líneas de pedidos por día**  
Order lines per day

**+ 30.000 m<sup>2</sup>** 

**10**   
**Filiales comerciales**  
Business subsidies

**Instalaciones productivas y logísticas**  
Production and logistics facilities



**Ser fabricantes,  
tu mejor garantía**  
As manufacturers, we  
assure the best guarantee.

## Speed PRO camping y marina

Para viajar cómodamente en autocaravana y poder estacionar en campings o espacios habilitados, es necesario disponer de equipos electrónicos que ofrezcan instalaciones eléctricas seguras.

Ahora, la nueva línea de clavijas y bases industriales para camping y marina incluye una gama de bases de empotrar con **microinterruptores**, una herramienta eficaz en la gestión de energía además de sumar seguridad eliminando el arco eléctrico.

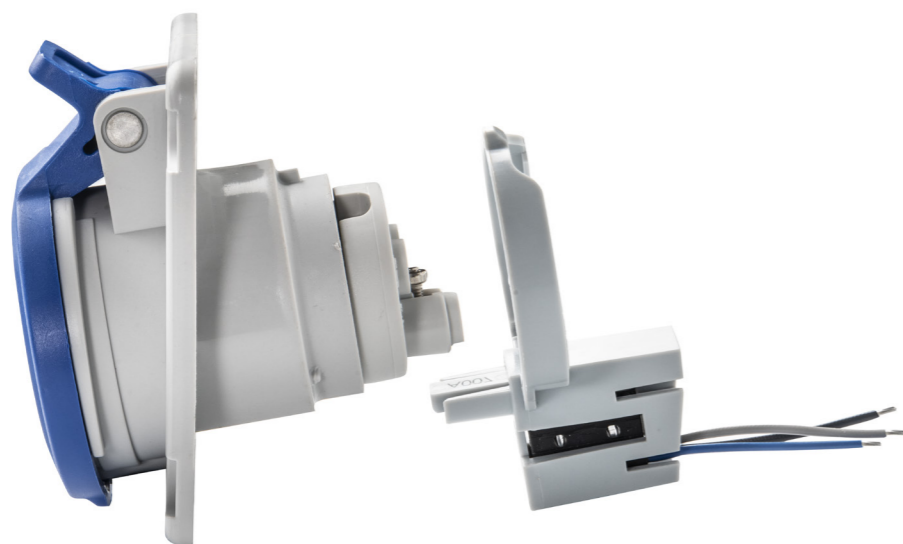

## Speed PRO camping & marina

Electrical installations at camping are necessary to provide comfort and safety for travelers around the world. Be during a camping trip or in a parking lot home trailers, have the correct electronic equipment is impressive to provide or higher level of security.

Now, the new line of industrial plugs and sockets for camping and marine, includes a range of flush-mounted sockets with **microswitches**, an effective tool in the management of the power plant, as well as adding safety by eliminating the electric arc.

### Características técnicas / Technical features

Tensión de utilización / Operating voltage	200...250V / 380...415V
Tensión de aislamiento / Insulating voltage	500 V
Frecuencia / Frequency C.C.	50/60 Hz
Intensidad Nominal / Rated current	16A-32A
Grado de Protección / Protection degree IE(IP C / EN 60529)	IP54 / IP67
Máxima temperatura de funcionamiento / Maximum operating temperature TESTED	+70 °C
Temperatura de uso según norma de referencia / Temperature of use according to the norm	-25 °C / +40 °C
<b>Material / Material</b>	
Material del cuerpo / Body material	Poliamida 6 - NYLON / Polyamide 6 - NYLON
Material de contacto / Contact material	Latón - Latón niquelado / Brass - Nickel-plated brass

### Normativa / Regulation

IEC 60309-1; IEC 60309-2; EN 61058-1-1:2016, EN IEC 61058-1:2018

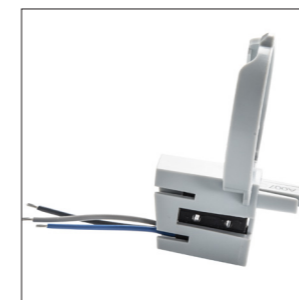

**Microinterruptor con contacto NO-NC. Disponible en versiones IP44-54 y IP66-67.**

**Longitud del cable del microinterruptor de 50cm.**

**Microswitch with NO-NC contact. Available in IP44-54 and IP66-67 versions.**

**Microswitch cable length 50cm.**



**Tapa con diseño especial para candado.**

Cover specially designed for padlock.



**Diámetro máximo del candado 5mm**

Maximum padlock diameter 5mm

**Nueva medida 64x74cm**

New size 64x74cm

Refs. / Items 23M238L

**Base con diseño especial para candado compatible con clavija móvil 13200L.**

Socket with special design for padlock compatible with mobile plug 13200L.



**SpeedPRO** Base de empotrar para candado/ Panel socket for lock

3P = 2P + T

<b>230V</b> 50/60Hz			
Amp	Poles	Pack unit	Poles: 3P Hour P: 6h
16	3	10	<b>23238L</b>

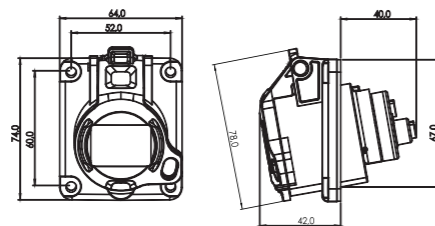

Ref. / Item **23238L**

- Terminales con tornillo
- Material: PA6
- Contactos: Latón
- Peso: 115g
- Cable flexible (mm2): 1+2,5
- Grado de protección: **IP44-54**
- With screw terminals
- Housing material: PA6
- Contacts: Brass
- Weight: 115g
- Flexible cable (mm2): 1+2,5
- Degree of protection: **IP44-54**

**SpeedPRO** Base de empotrar para candado con **microinterruptor**/ **Microswitch** panel socket for lock

3P = 2P + T

<b>230V</b> 50/60Hz			
Amp	Poles	Pack unit	Poles: 3P Hour P: 6h
16	3	10	<b>23M238L</b>

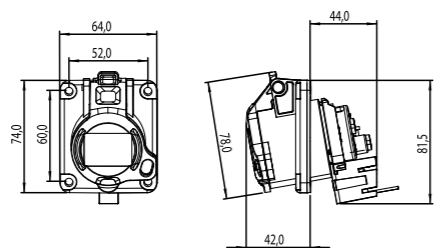

Ref. / Item **23M238L**

- Terminales con tornillo
- Material: PA6
- Contactos: Latón
- Peso: 140g
- Cable flexible (mm2): 1+2,5
- Grado de protección: **IP44-54**
- With screw terminals
- Housing material: PA6
- Contacts: Brass
- Weight: 140g
- Flexible cable (mm2): 1+2,5
- Degree of protection: **IP44-54**

**SpeedPRO** Clavija móvil para candado/ Mobile plug for lock

3P = 2P + T

<b>230V</b> 50/60Hz			
Amp	Poles	Pack unit	Poles: 3P Hour P: 6h
16	3	10	<b>13200L</b>

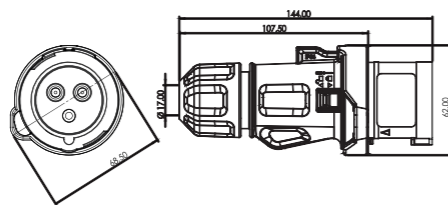

Ref. / Item **13200L**

- Terminales con tornillo
- Material: PA6
- Contactos: Niquelados
- Peso: 162
- Cable flexible (mm2): 1+2,5
- Grado de protección: **IP44-54**
- With screw terminals
- Housing material: PA6
- Contacts: Nickelplated
- Weight: 162
- Flexible cable (mm2): 1+2,5
- Degree of protection: **IP44-54**

**SpeedPRO** Base de empotrar 64x74/ Panel socket 64x74

3P = 2P + T

<b>230V</b> 50/60Hz			
Amp	Poles	Pack unit	Poles: 3P Hour P: 6h
16	3	10	<b>23236</b>

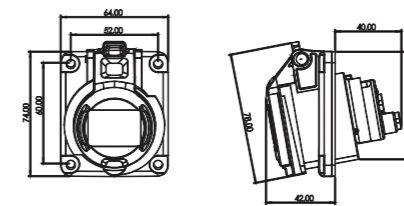

Ref. / Item **23236**

- Terminales con tornillo
- Material: PA6
- Contactos: Latón
- Peso: 112g
- Cable flexible (mm2): 1+2,5
- Grado de protección: **IP44-54**
- With screw terminals
- Housing material: PA6
- Contacts: Brass
- Weight: 115g
- Flexible cable (mm2): 1+2,5
- Degree of protection: **IP44-54**

**SpeedPRO** Base de empotrar 64x74/ Panel socket 64x74

3P = 2P + T

<b>230V</b> 50/60Hz			
Amp	Poles	Pack unit	Poles: 3P Hour P: 6h
16	3	10	<b>23237</b>

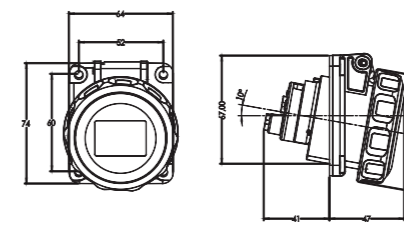

Ref. / Item **23237**

- Terminales con tornillo
- Material: PA6
- Contactos: Latón
- Peso: 135g
- Cable flexible (mm2): 1+2,5
- Grado de protección: **IP66-67**
- With screw terminals
- Housing material: PA6
- Contacts: Brass
- Weight: 135g
- Flexible cable (mm2): 1+2,5
- Degree of protection: **IP66-67**

**SpeedPRO** Base de empotrar con **microinterruptor** 64x74/ **Microswitch** panel socket 64x74

3P = 2P + T

<b>230V</b> 50/60Hz			
Amp	Poles	Pack unit	Poles: 3P Hour P: 6h
16	3	10	<b>23M236</b>

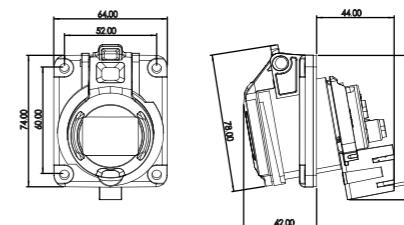

Ref. / Item **23M236**

- Terminales con tornillo
- Material: PA6
- Contactos: Latón
- Peso: 137
- Cable flexible (mm2): 1+2,5
- Grado de protección: **IP44-54**
- With screw terminals
- Housing material: PA6
- Contacts: Brass
- Weight: 137
- Flexible cable (mm2): 1+2,5
- Degree of protection: **IP44-54**

**SpeedPRO** Base de empotrar con **microinterruptor** 64x74/ **Microswitch** panel socket 64x74

3P = 2P + T

<b>230V</b> 50/60Hz			
Amp	Poles	Pack unit	Poles: 3P Hour P: 6h
16	3	10	<b>23M237</b>

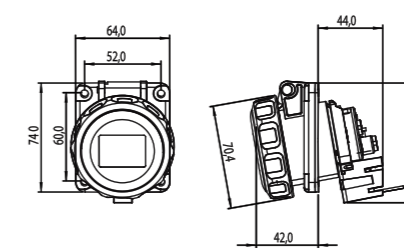

Ref. / Item **23M237**

- Terminales con tornillo
- Material: PA6
- Contactos: Latón
- Peso: 162
- Cable flexible (mm2): 1+2,5
- Grado de protección: **IP66-67**
- With screw terminals
- Housing material: PA6
- Contacts: Brass
- Weight: 162
- Flexible cable (mm2): 1+2,5
- Degree of protection: **IP66-67**

**Microinterruptor**

Controla el estado de conexión y desconexión de las tomas desde cualquier punto de tu instalación. El microinterruptor se activa al introducir el enchufe en la toma. Se puede utilizar para crear un bloqueo de seguridad eléctrico o enviar señales a otros dispositivos.

**Micro switch**

Control the connection and disconnection status of the sockets from any point of your installation. The microswitch is activated when the plug is inserted into the socket. It can be used to create an electrical safety interlock or send signals to other devices.



SpeedPRO Base de empotrar con **microinterruptor** 75x85/ **Microswitch** panel socket 75x85

16	3	10	23M230	
	4	10		23M330
	5	5		23M331
32	3	4	23M233	
	4	4		23M332
	5	3		23M333

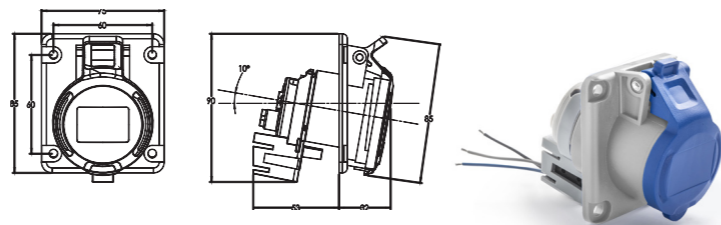

Ref./Item **23M230**

- Terminales con tornillo
- Material: PA6
- Contactos: Latón
- Peso: 115g
- Cable flexible (mm2): 1+2,5
- Grado de protección: **IP44-54**
- With screw terminals
- Housing material: PA6
- Contacts: Brass
- Weight: 115g
- Flexible cable (mm2): 1+2,5
- Degree of protection: **IP44-54**

SpeedPRO Base de empotrar con **microinterruptor** 75x85/ **Microswitch** panel socket 75x85

16	3	10	24M230	
	4	10		24M330
	5	6		24M331
32	3	6	24M233	
	4	6		24M332
	5	6		24M333

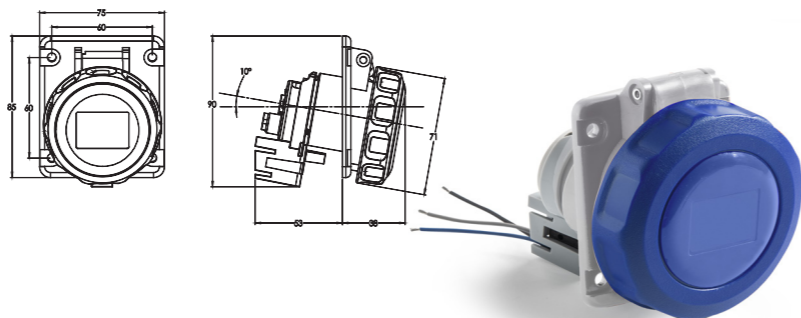

Ref./Item **24M230**

- Terminales con tornillo
- Material: PA6
- Contactos: Latón
- Peso: 123g
- Cable flexible (mm2): 1+2,5
- Grado de protección: **IP66-67**
- With screw terminals
- Housing material: PA6
- Contacts: Brass
- Weight: 1140g
- Flexible cable (mm2): 1+2,5
- Degree of protection: **IP66-67**



Dimensiones en mm / Dimensions in mm

Adaptador industrial-doméstico IP44 / Industrial-domestic IP44

Ref./Item	<b>13000</b>
<ul style="list-style-type: none"> <li>• Adaptador industrial-doméstico con prolongación IP44</li> <li>• Industrial-domestic adaptor with cable extension IP44</li> </ul>	

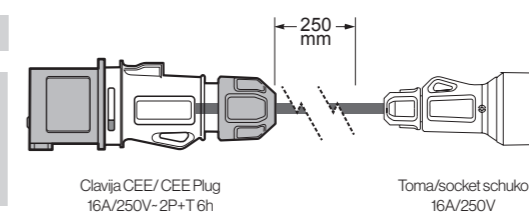

Ref./Item **13000**

Adaptador industrial-doméstico IP44 / Industrial-domestic IP44

Ref./Item	<b>13011</b>
<ul style="list-style-type: none"> <li>• Adaptador industrial-doméstico con prolongación IP44</li> <li>• Industrial-domestic adaptor with cable extension IP44</li> </ul>	

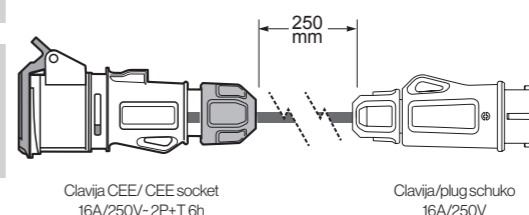

Ref./Item **13011**

Adaptador doméstico-industrial IP20 / Domestic-industrial IP20

Ref./Item		<b>13912</b>															
<table border="1"> <tr> <td></td> <td>A</td> <td>B</td> </tr> <tr> <td>Dimensions</td> <td>80</td> <td>60</td> </tr> <tr> <td>Entrada / Entry</td> <td colspan="2">Clavija/plug schuko 16A/250V</td> </tr> <tr> <td>Salida / Outlet</td> <td colspan="2">Toma/socket ind. CEE 16A/250V-2P+T 6h</td> </tr> <tr> <td>Weight (g)</td> <td colspan="2">164</td> </tr> </table>				A	B	Dimensions	80	60	Entrada / Entry	Clavija/plug schuko 16A/250V		Salida / Outlet	Toma/socket ind. CEE 16A/250V-2P+T 6h		Weight (g)	164	
	A	B															
Dimensions	80	60															
Entrada / Entry	Clavija/plug schuko 16A/250V																
Salida / Outlet	Toma/socket ind. CEE 16A/250V-2P+T 6h																
Weight (g)	164																

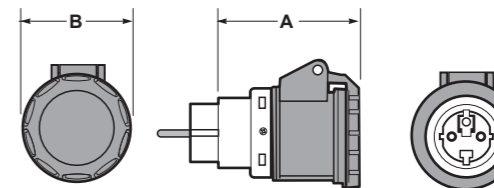

Ref./Item **13912**

Adaptador industrial-doméstico IP20 / Industrial-domestic IP20

Ref./Item			<b>13913</b>															
<table border="1"> <tr> <td></td> <td>A</td> <td>B</td> </tr> <tr> <td>Dimensions</td> <td>120</td> <td>85</td> </tr> <tr> <td>Entrada / Entry</td> <td colspan="2">Clavija CEE/CEE plug 16A/250V-2P+T 6h</td> </tr> <tr> <td>Salida / Outlet</td> <td colspan="2">3 Tomas/sockets Bipasso 16A/250V</td> </tr> <tr> <td>Weight (g)</td> <td colspan="2">164</td> </tr> </table>					A	B	Dimensions	120	85	Entrada / Entry	Clavija CEE/CEE plug 16A/250V-2P+T 6h		Salida / Outlet	3 Tomas/sockets Bipasso 16A/250V		Weight (g)	164	
	A	B																
Dimensions	120	85																
Entrada / Entry	Clavija CEE/CEE plug 16A/250V-2P+T 6h																	
Salida / Outlet	3 Tomas/sockets Bipasso 16A/250V																	
Weight (g)	164																	

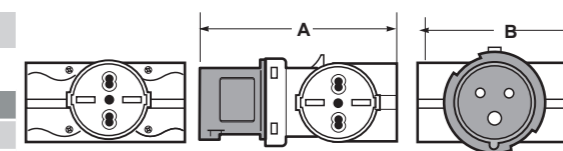

Ref./Item **13913**

Base industrial móvil a 90° con toma schuko para caravana IP44  
Industrial socket angled 90° with Schuko socket for caravan IP44

Ref./Item		<b>13919</b>															
<table border="1"> <tr> <td></td> <td>A</td> <td>B</td> </tr> <tr> <td>Dimensions</td> <td>80</td> <td>60</td> </tr> <tr> <td>Entrada / Entry</td> <td colspan="2">Clavija/plug schuko 16A/230V 3P</td> </tr> <tr> <td>Salida / Outlet</td> <td colspan="2">CEE 16A 2P+T 230V + Schuko 16A 2P+T 230V</td> </tr> <tr> <td>Weight (g)</td> <td colspan="2">101</td> </tr> </table>				A	B	Dimensions	80	60	Entrada / Entry	Clavija/plug schuko 16A/230V 3P		Salida / Outlet	CEE 16A 2P+T 230V + Schuko 16A 2P+T 230V		Weight (g)	101	
	A	B															
Dimensions	80	60															
Entrada / Entry	Clavija/plug schuko 16A/230V 3P																
Salida / Outlet	CEE 16A 2P+T 230V + Schuko 16A 2P+T 230V																
Weight (g)	101																



Ref./Item **13919**

Sistema / System SCHUKO  
Dimensiones en mm / Dimensions in mm

Adaptador IP20 / Adaptor IP20

Ref. / Item		<b>13917</b>	
Dimensions	A	B	C
Entrada / Entry	Clavija CEE /CEE plug 16A 3P+N+T 400V		
Salida / Outlet	Toma/socket schuko 16A 2P+T 230V		
Weight (g)	152		

Ref. / Item **13917**

Adaptador IP54 / Adaptor IP54

Ref. / Item		<b>13910</b>	
Salida / Outlet	Toma/socket schuko 16A 2P+T 230V		
Ref. / Item		<b>13910DK</b>	
Salida / Outlet	Toma/socket schuko 16A 2P+T 230V		
Ref. / Item		<b>13910IR</b>	
Salida / Outlet	Toma/socket schuko 16A 2P+T 230V		
Ref. / Item		<b>13910FR</b>	
Salida / Outlet	Toma/socket schuko 16A 2P+T 230V		
Ref. / Item		<b>13910BR</b>	
Salida / Outlet	Toma/socket schuko 10A 2P+T 230V		
Dimensions	A	B	C
Entrada / Entry	Clavija CEE /CEE plug 16A 2P+T 230V		
Weight (g)	155		

Ref. / Item **13910**

Adaptador IP54 / Adaptor IP54

Ref. / Item		<b>13922</b>	
Salida / Outlet	Toma/socket schuko 16A 2P+T 230V		
Ref. / Item		<b>13922DK</b>	
Salida / Outlet	Toma/socket schuko 16A 2P+T 230V		
Ref. / Item		<b>13922IR</b>	
Salida / Outlet	Toma/socket schuko 16A 2P+T 230V		
Ref. / Item		<b>13922FR</b>	
Salida / Outlet	Toma/socket schuko 16A 2P+T 230V		
Ref. / Item		<b>13922BR</b>	
Salida / Outlet	Toma/socket schuko 10A 2P+T 230V		
Dimensions	A	B	C
Entrada / Entry	Clavija CEE /CEE plug 16A 3P+N+T 400V		
Weight (g)	185		

Ref. / Item **13922**

Adaptador IP20 / Adaptor IP20

Ref. / Item		<b>13918</b>
Entrada / Entry	Clavija CEE /CEE plug 3P+N+T 400V	
Salida / Outlet	Toma/socket schuko 3x(16A 2P+T 230V)	
Weight (g)	196	

Ref. / Item **13918**

Clavija empotrable basculante para caravana IP44 / Fush mounting plug for caravan IP44

Ref. / Item		<b>13361</b>	
Ref. / Item		<b>13362</b>	
Dimensions	B	C	D
Entrada / Entry	Clavija/plug 16A/230V 3P		
Prot. / Protection			
Weight (g)	164		

Ref. / Item **13361**

Clavija empotrable basculante para caravana IP44 / Fush mounting plug for caravan IP44

Ref. / Item		<b>13364</b>	
Dimensions	B	C	D
Entrada / Entry	Clavija/plug 16A/230V 3P		
Prot. / Protection	Interruptor magnetotérmico 1P+N/MCB1P + N		
Weight (g)	164		

Ref. / Item		<b>13365</b>	
Dimensions	B	C	D
Entrada / Entry	Clavija/plug 16A/230V 3P		
Prot. / Protection	Interruptor diferencial 1P+N/RCD1P + N		
Weight (g)	164		

Ref. / Item **13364**



**Famatel**®

**famatel.com**

Av. El Pla, 11. P.I. El Pla.  
08185 Lliçà de Vall  
Barcelona - Spain  
T. + 34 938 634 640  
info@famatel.com  
export@famatel.com

 [.../company/famatelgroup](https://www.linkedin.com/company/famatelgroup)  
 [youtube.com/@famatelgroup](https://www.youtube.com/@famatelgroup)  
 [instagram.com/famatelgroup](https://www.instagram.com/famatelgroup)