

ADAPTADORES INDUSTRIAL - SCHUKO / MULTIPLE INDUSTRIAL SCHUKO

Referencias / References

Ref. / Item		16010
Salida / Outlet	2 ind. CEE 2P+T 16A/250V 6h + 1 schuko toma/socket 16A/250V	



Ref. / Item 16010 

Dimensiones y conexiones / Dimensions & connections

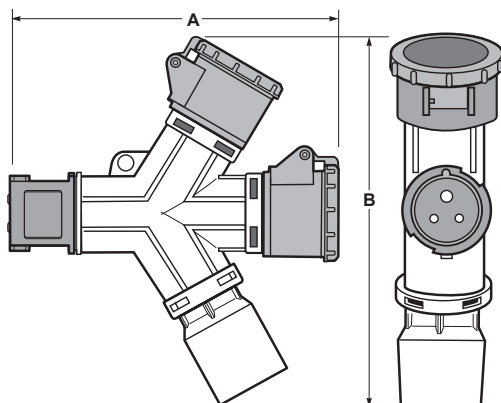

	16A/250-2P+T	
	A	B
Dimensions	226	237
Entrada / Entry	Clavija CEE / CEE plug 16A/250V~ 2P+T 6h	
Weight (g)	530	

Dimensiones en mm / Dimensions in mm

Características Técnicas / Technical Data

Tensión de Utilización / Operating Voltage	■ 200...250V	Grado de Protección / Protection Degree	IP20 (IEC / EN 60529)
Intensidad Nominal / Rated Current	16A	Resistencia al Impacto / Impact Resistance	IK08 (IEC / EN 62262)
Frecuencia / Frequency	50/60 Hz	Material / Material	Soporte partes activas / Live parts support: PA6 Cuerpo / Body: ABS
Resistencia de Aislamiento / Insulating Resistance	>10 MΩ	Material de contacto / Contact material	Latón Brass
Rigidez Dieléctrica / Dielectric Strength	2,5 kV	Temperatura de funcionamiento / Operating Temperature	-25°C / +40°C
Prueba Hilo Incandescente / Glow Wire Test	850°C partes soportan partes activas / parts support live parts 650°C Otras partes / Other parts (IEC / EN 60695-2-10)	Ensayo de bola / Ball pressure test	125°C partes soportan partes activas / parts support live parts 80°C Otras partes / Other parts (IEC / EN 60695-10-2)
Utilización / Use	Uso Temporal / Temporary Use	Normativa aplicada / Applied Standards	IEC 60309-1, IEC 60309-2 UNE 20315-1-1; UNE 20315-1-2 (IEC 60884-1) Low Voltage Directive 2014/35/UE